

IMPORTANT SAFETY RULES

Read, understand, and follow
all instructions carefully before
installing and using this product.
Keep for future reference.

ZX300 Deluxe Automatic Pool Cleaner



Don't forget to try these other fine Intex products:
pools, pool accessories, inflatable pools and in-home
toys, airbeds and boats available at fine retailers or
visit our website.

Due to a policy of continuous product improvement,
Intex reserves the right to change specifications and
appearance, which may result in updates to the
instruction manual without notice.

OWNER'S MANUAL

INTEX®

©2023 Intex Marketing Ltd. - Intex Development Co. Ltd. - Intex Recreation Corp. All rights reserved/Tous droits réservés/Todos los derechos reservados/Alle Rechte vorbehalten. Printed in China/Imprimé en Chine/Impreso en China/Gedruckt in China.

©™ Trademarks used in some countries of the world under license from/®™ Marques utilisées dans certains pays sous licence de/Marcas registradas utilizadas en algunos países del mundo bajo licencia de/Warenzeichen verwendet in einigen Ländern der Welt in Lizenz von/Intex Marketing Ltd. to/à/a/an Intex Development Co. Ltd., Hong Kong & Intex Recreation Corp., P.O. Box 1440, Long Beach, CA 90801 - Distributed in the European Union by/Distribué dans l'Union Européenne par/Distribuido en la unión Europea por/Vertrieb in der Europäischen Union durch/Intex Trading B.V., Ettenseweg 46, 4706 PB Roosendaal - The Netherlands - Distributed in the UK by Unitex Service (UK) Limited, 21 Holborn Viaduct, London EC1A 2DY, UK.

www.intexcorp.com

178-^{*}A-R0-2407

TABLE OF CONTENTS

Warnings.....	3
Parts Reference.....	4
Set Up Instructions.....	5-11
Debris Net Cleaning.....	11-12
Micro-screen Cleaning.....	13
Roller Brush Replacement.....	14-15
Troubleshooting Guide.....	16-17
Long Term Storage.....	18
General Aquatic Safety.....	18
Limited Warranty.....	19

SAVE THESE INSTRUCTIONS

Page 2

IMPORTANT SAFETY RULES

Read, Understand and Follow All Instructions Carefully Before Installing and Using this Product.

WARNING

- TO REDUCE THE RISK OF INJURY, DO NOT PERMIT CHILDREN TO USE THIS PRODUCT.
- REMOVE THE PRODUCT FROM THE POOL WHILE THE POOL IS OCCUPIED OR IN USE.
- TURN OFF OR UNPLUG THE FILTER PUMP BEFORE ADJUSTING, CLEANING OR SERVICING.
- REMOVE THE PRODUCT FROM THE POOL BEFORE PLACING A POOL COVER OVER THE POOL.
- STORE THE PRODUCT AND ACCESSORIES IN A DRY AND SAFE PLACE INDOORS.
- FOR POOL AND FILTER PUMP PROBLEMS REFER TO THEIR RESPECTIVE OWNER'S MANUAL FOR ADVICE.
- THIS DEVICE IS INTENDED TO BE USED ONLY FOR THE PURPOSES DESCRIBED IN THE MANUAL.

FAILURE TO FOLLOW THESE WARNINGS MAY RESULT IN PROPERTY DAMAGE, SERIOUS INJURY OR DEATH.

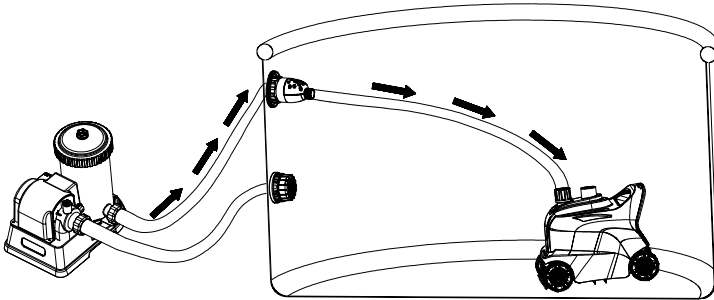

SAVE THESE INSTRUCTIONS

PARTS REFERENCE

Before assembling your product, please take a few minutes to check the contents and become familiar with all the parts.

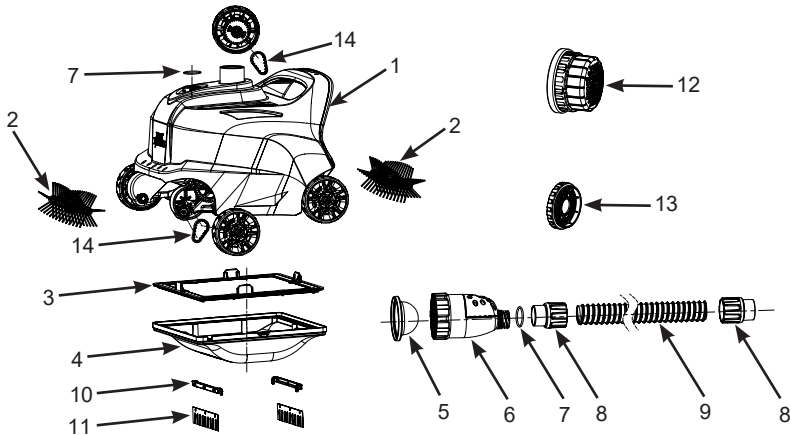

NOTE: Drawings for illustration purpose only. Actual product may vary. Not to scale.

REF. NO.	DESCRIPTION	QTY.	SPARE PARTS NO.
1	CLEANER TOP	1	13346
2	ROLLER BRUSH	2	12928
3	DEBRIS NET	1	13134
4	CLEANER BASE	1	13133
5	MICRO-SCREEN	1	13343
6	PRESSURE RELEASE VALVE	1	13345
7	O-RING	2	12861
8	HOSE COLLAR NUT	2	12863
9	HOSE	1	12862G
10	BRUSH SUPPORT (WITH 2 EXTRA)	4	13136
11	BRUSH (WITH 10 EXTRA)	12	13135
12	STRAINER GRID EXTENSION FITTING	1	13047
13	INLET CONNECTOR ADAPTOR	1	12486
14	SYNCHRONOUS BELT	2	13344

SAVE THESE INSTRUCTIONS

SETUP INSTRUCTIONS

IMPORTANT PREPARATION INFORMATION

Please read, understand, and follow all instructions carefully before installing and using this product.

General

- The Auto Cleaner operates from the pressure side of the pool water return connector (water from the filter pump to the pool).
- If an Intex Saltwater System or Ozone Generator is attached to the pool, disconnect these sanitation devices from the circulation line first before operating the Auto Cleaner. Once the Auto Cleaner has finished cleaning the pool, disconnect, remove the Auto Cleaner from the pool and resume the sanitation device operation.
- The Auto Cleaner must be connected to an Intex filter pump with a system flow rate between 1600 - 3500 gallons/hour (6056 - 13248 liters/hour). Not suitable for non-Intex filter pumps.
- For Intex® above ground frame pools (not suitable for Easy Set Pools or pools with inflatable top ring).
 - Up to 26 ft (7.92 m) round shape.
 - Up to 32 ft x 16 ft (9.75 m x 4.88 m) rectangular/oval shape.
- First assemble your pool and filter pump, and then set up the auto cleaner.
- If using a sand filter, ensure the sand media is clean by backwashing it first. Run the filter pump for 10-15 minutes before connecting the auto cleaner to the water return connector.
- The auto cleaner will not work if the filter pump is not operating.
- The auto cleaner is designed to clean the pool as follow:
 - The brushes from the auto cleaner remove the fine dirt from the wall and floor.
 - The fine sediments and debris on the floor are agitated by the auto cleaner movement. This allows the filtration system to filter out the fine sediments suspended in the water, while the auto cleaner pick up the heavy debris on the floor.
 - The movement of the auto cleaner around the pool prevents the water from stagnating. Thus helping circulate the pool water through the filtration system.

SAVE THESE INSTRUCTIONS

SETUP INSTRUCTIONS (continued)

Before setup, make sure that:

- The filter pump is turned off, and disconnect the power cord from the electrical outlet.
 - The pool is free from objects that will hinder the auto cleaner free movements by removing the ladder, surface skimmer, water sprayer (if applicable), floats or any other objects from the pool.
 - The pool wall or floor are free from algae. Algae will cause the wheels to slip, block the flow of water into the cleaner and hinder the auto cleaner movement. Treat the pool water with algacide and wait for the algae to shed before using the auto cleaner. See your local pool supply specialist for algae treatment solutions. Check and clean the debris net more frequently.
1. From inside of the pool, unscrew the nozzle from the water return connector. See Fig. 1.

NOTE: The device operates from the pressure side of the pool water return connector (water flowing back from the filter pump to the pool).

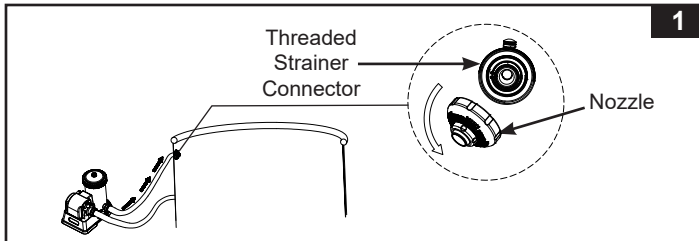

2. Check your filtration system **pump flow rate** and adjust the pressure release valve **(6)** button as follow:
 - For pump flow rate between 2100-2800 gph (7950-10600 L/h) or equivalent system flow rate between 1600-2150 gph (6056-8138 L/h): press button for “**DOWN**” position.
 - For pump flow rate greater than 2800 gph (10600 L/h) or equivalent system flow rate 2150 gph (8138 L/h) but not exceeding 3500 gph (13248 L/h) or equivalent system flow rate 3000 gph (11355 L/h): button shall be in the “**UP**” position. If the button is already in the “**DOWN**” position, press button once to return it to the “**UP**” position. See Fig. 2.

SAVE THESE INSTRUCTIONS

SETUP INSTRUCTIONS (continued)



3. Make sure the micro-screen (5) is inside the pressure release valve (6), then screw the pressure release valve set to the threaded strainer connector, from inside of the pool. See Fig. 3.
NOTE: For Intex small pools with 1-1/4" (32mm) inlet strainer connector fitting, screw the inlet connector adaptor (13) to the inlet strainer connector first, then screw the pressure release valve set to the adaptor (13).

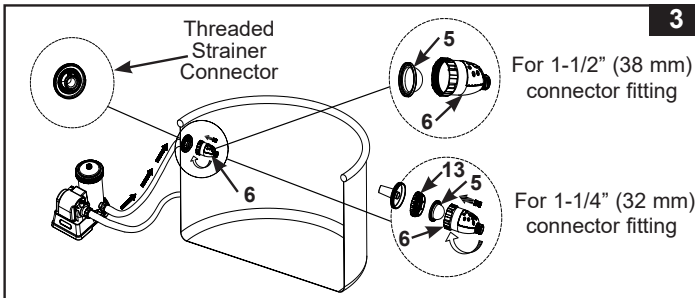

4. From inside of the pool, attach the strainer grid extension fitting (12) over the suction outlet strainer grid. See Fig. 4.



NOTE: Remove the strainer grid extension fitting (12) from the suction outlet grid when the auto cleaner is not in use or disconnected from the pool.

SAVE THESE INSTRUCTIONS

SETUP INSTRUCTIONS (continued)

5. Screw the hose (9) with the hose collar nut (8) to the pressure release valve set (6). See Fig. 5.

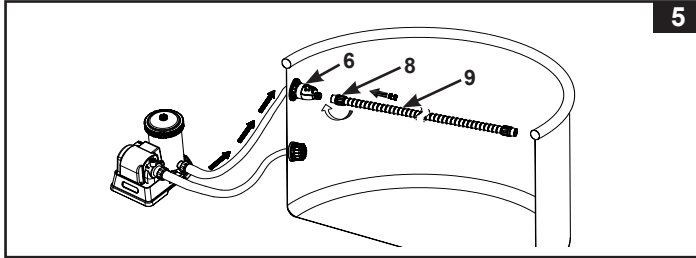

6. Extend the hose (9) to the furthest opposite side of the pool wall or to the furthest corner of the pool so that it overhangs the wall, and then cut the excess hose with a scissor. See Fig. 6.

Note: Unscrew (clockwise direction) the hose collar nut (8) from the other end of the hose (9) before cutting the excess hose. Screw (counter-clockwise direction) the hose collar nut (8) back onto the main hose (9) after cutting.

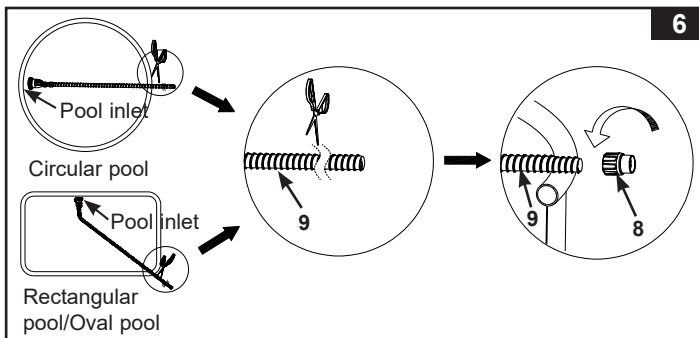

SAVE THESE INSTRUCTIONS

SETUP INSTRUCTIONS (continued)

7. Brush assembly. See Fig. 7.

NOTE: Remove the brushes from underneath the device when vacuuming large debris or leaves on the pool floor.



8. From outside of the pool, connect the other end of hose with the hose collar nut (8) to the auto pool cleaner water inlet. Vertically insert the hose collar nut (8) into the water inlet, while pushing down the hose collar nut, turn the hose collar nut clockwise to tighten the hose. To remove the hose, while pushing down the hose collar nut, turn the collar nut counter-clockwise. See Fig. 8.



SAVE THESE INSTRUCTIONS

SETUP INSTRUCTIONS (continued)

9. Hold the cleaner with the top facing up. Slowly lower the device into the water to evacuate the air inside the cleaner and the cleaner will gradually sink to the bottom of the pool floor. Stretch out the hose by slowly pulling the auto cleaner across the pool to the opposite side. Make sure the hose is stretched out in order to prevent any entanglement. See Fig. 9.



10. Turn on the filter pump and make sure water is flowing through the micro-screen (5) and the pressure release valve (6). The auto cleaner is now moving and vacuuming the pool floor and pool wall. See Fig. 10.

Note: The cartridge filter pump or sand filter pump will clean the pool water. It's essential to clean or replace the filter cartridge or backwash sand media frequently to keep the water clean. If the Auto Cleaner is paired up with a sand filter pump, the system flow will diminish and the pressure will rise as indicated by the sand filter pump pressure gauge reading (from green to yellow zone), this is normal. Disconnect the Auto Cleaner from the pool and check if the sand filter pressure gauge reading will drop back to the green zone. Refer to the sand filter pump manual for more details.



SAVE THESE INSTRUCTIONS

SETUP INSTRUCTIONS (continued)

IMPORTANT NOTE

If the auto cleaner starts to stir the debris, sediments on the pool floor, you will require to clean or replace the filter cartridge more frequently as the fine sediments are retained by the cartridge. Also clean the debris net (3) and micro-screen (5) frequently.

DEBRIS NET CLEANING

1. Make sure the filter pump is turned off, and disconnect the power cord from the electrical outlet.
2. Lift the auto cleaner's hose slowly then grasps the auto cleaner handle. See Fig. 11-12.
CAUTION: Do not pull the hose directly which could damage the auto cleaner hose connection fitting.
3. Slowly lift up the auto cleaner from the water. Once all the water has been released from the auto cleaner, remove the auto cleaner from the pool and place it on the ground. See Fig. 13.

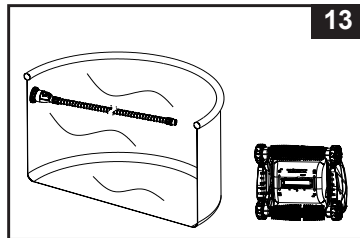
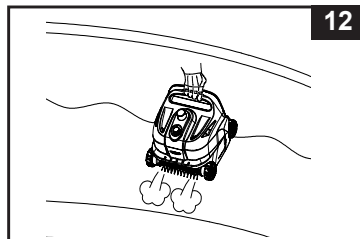
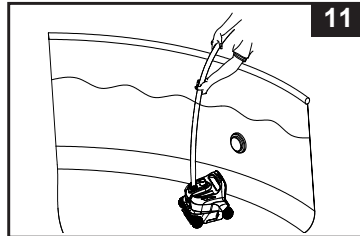

SAVE THESE INSTRUCTIONS

DEBRIS NET CLEANING (continued)

4. Push the left and right levers to the unlock position. See Fig. 14.



5. Remove the debris net (3) from the cleaner base (4). If debris is on the debris net and cleaner base, use garden hose to flush the debris off. See Fig. 15.

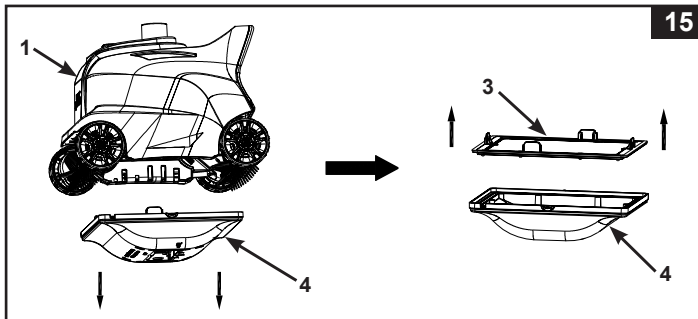

6. Reassemble auto cleaner debris net and base by reversing previous steps.

SAVE THESE INSTRUCTIONS

MICRO-SCREEN CLEANING

1. Make sure the filter pump is turned off, and disconnect the power cord from the electrical outlet.
2. To remove the hose, unscrew (counter-clockwise direction) the hose collar nut (8) from the pressure release valve (6). See Fig. 16.

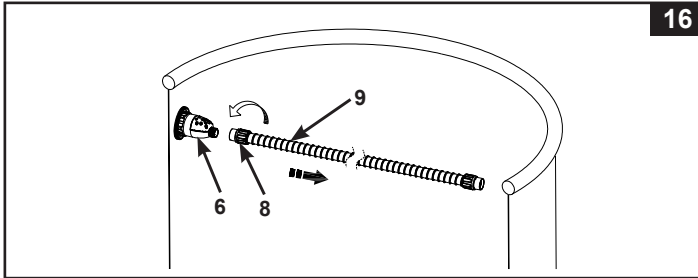

3. Unscrew the pressure release valve (6) from the threaded strainer connector. Remove the micro-screen (5) from the pressure release valve. Use a garden hose to clean and flush out any debris from the micro-screen and pressure release valve. See Fig. 17.

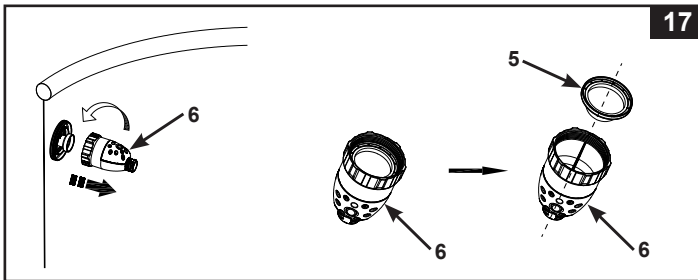

4. Reassemble all the components back by reversing previous steps.

SAVE THESE INSTRUCTIONS

ROLLER BRUSH REPLACEMENT

1. Make sure the filter pump is turned off, and disconnect the power cord from the electrical outlet.
2. Remove the auto cleaner from the pool and place it on the ground. See Fig. 18.

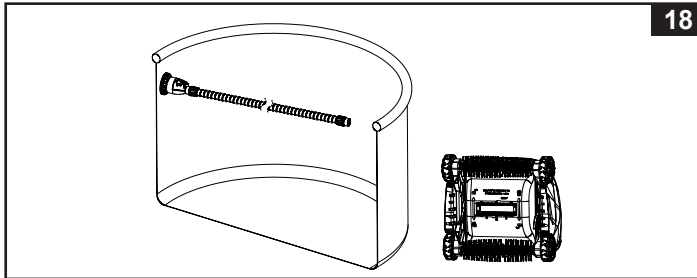

3. Hold the left side of the roller brush with your fingers, pull it to the right, and then lift it up to take out the roller brush. See fig. 19.

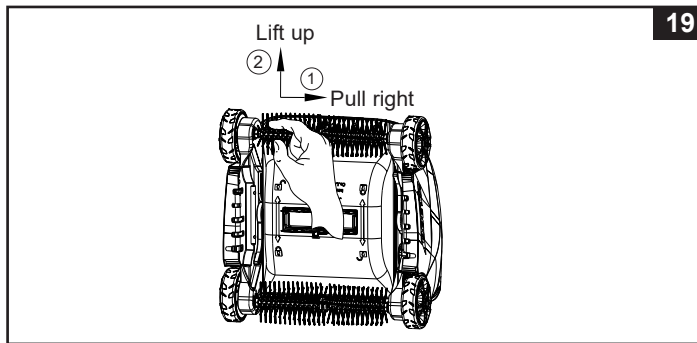

SAVE THESE INSTRUCTIONS

ROLLER BRUSH REPLACEMENT (continued)

4. To install the new roller brush, align and insert one end of the roller brush protruding column into the auto cleaner right side hole. See Fig. 20. Hold the left side of the roller brush with your fingers and pull it to the right, and then insert the other end of the roller brush into the auto cleaner left side hole. See Fig. 21. Make sure the roller brush is securely attached by moving it side ways.

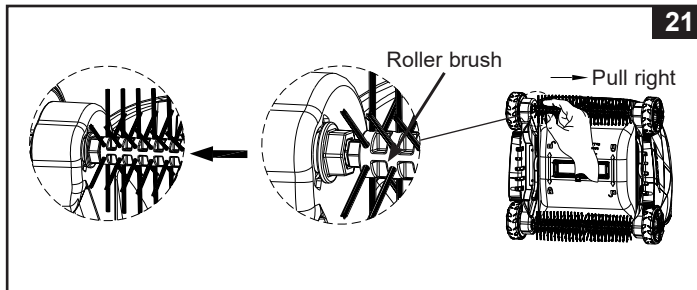
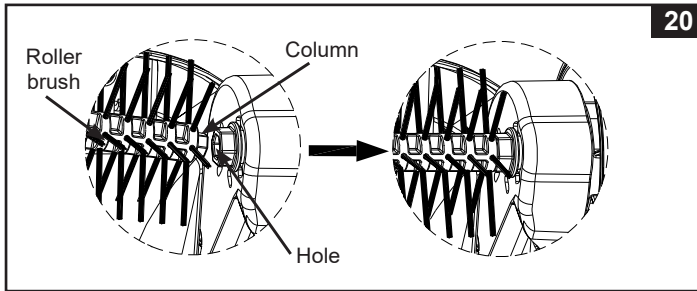

SAVE THESE INSTRUCTIONS

TROUBLESHOOTING GUIDE

TROUBLE	SOLUTION
AUTO CLEANER DOESN'T MOVE	<ul style="list-style-type: none"> • Ensure the filter pump is operating and within the specified pump flow rate [1600 - 3500 gallons/hour (6056 - 13248 liters/hour)]. • Lift the auto cleaner out of the water and check if water is flowing out from the "water outlet" located on the top of the device. • Tighten the hose collar nut securely, and connect the hose to the water return connector, see "Setup" section. If you are not sure which return connector is, try connecting the auto cleaner to each pool outlet until water is flowing out from the "water outlet". • Remove the cleaner base, check if the gear box is stuck, turn the wheels by hand and see if the wheels rotate, if not, replace a new unit. • Contact Intex Service Center.
MOVEMENT IS VERY SLOW	<ul style="list-style-type: none"> • Check and clean the debris net and micro-screen. • Clean or replace the filter pump cartridge. • If using a sand filter, ensure the sand media is clean by backwashing it. See sand filter owner's manual.
CLEANER CAN NOT CLIMB THE POOL WALL	<ul style="list-style-type: none"> • Pool water too dirty or the wall is covered with algae. Ensure the pool water chemistry is balanced. If the pool water is green, brown or black, adjust the chlorine and pH level. See pool owner's manual. • Check if the pump flow rate is within the specified range, if the flow rate is less than 1600 gal/h (6056 liters/h), change the pump with a higher pump flow rate.
CAN NOT PICK UP THE LEAVES ON POOL FLOOR	<ul style="list-style-type: none"> • Remove the brushes from the underside and put the Auto Cleaner back into the pool, see "Setup" section. • Clean the debris net and micro-screen from the Auto Cleaner after operating for 2-3 hours continuously.
TAKES LONGER TIME TO REVERSE DIRECTION	<ul style="list-style-type: none"> • This is normal, as the auto cleaner reversing time is dictated by the size of the filter pump flow rate.

SAVE THESE INSTRUCTIONS

TROUBLESHOOTING GUIDE (continued)

TROUBLE	SOLUTION
HOSE IS ENTANGLED	<ul style="list-style-type: none"> • If the hose is coiled in a circle, it will not affect the auto cleaner movement around the pool. This is normal. • However, if the hose is entangled or twisted, this will hinder the auto cleaner movement. Stretch out the hose by slowly pulling the auto cleaner across the pool to the opposite side. Make sure the hose is stretched out before operating the auto cleaner. • Alternatively disconnect the hose from the pool and the auto cleaner, stretch out the hose on a flat surface and let it warm up under the sun (24 hours) before using it.
SEDIMENTS ARE STIRRED UP FROM THE POOL FLOOR	<ul style="list-style-type: none"> • As the auto cleaner move around, fine sediments on the pool floor will be stirred up causing the water to be cloudy. This is normal. • Run the filtration system and the auto cleaner longer. The filtration system will filter out the fine sediments suspended in the water, while the auto cleaner will pick up the heavy debris on the floor. Check and clean the filtration media and the debris net more frequently.
DEBRIS NET IS CLOGGED AND AUTO CLEANER IS SHUT OFF	<ul style="list-style-type: none"> • Present of algae in the pool. Treat the pool water with algaecide and wait for the algae to shed before using the auto cleaner. See your local pool supply specialist for algae treatment solutions. Check and clean the debris net more frequently. • Maintain proper pool water chemistry, see pool owner's manual for more details.

IMPORTANT

If you continue to experience difficulty, please contact our Consumer Service Department for assistance. See separate "Authorized Service Centers" sheet.

SAVE THESE INSTRUCTIONS

LONG TERM STORAGE

1. Make sure the filter pump is turned off, and disconnect the power cord from the electrical outlet.
2. Using the Set Up instructions in reverse, disassemble the auto cleaner. Remove the strainer grid extension fitting from the suction outlet grid at the same time.
3. Clean and air dry all the accessories and parts thoroughly.
4. Loosely roll up and avoid twisting the hose during storage. Do not put heavy objects on top of the hose.
5. Remove the brushes **(11)** and keep them flat and straight during storage.
6. The original packaging can be used for storage. Store in a dry, cool storage location.

GENERAL AQUATIC SAFETY

Water recreation is both fun and therapeutic. However, it involves inherent risks of injury and death. To reduce your risk of injury, read and follow all product, package and package insert warnings and instructions. Remember, however, that product warnings, instructions and safety guidelines cover some common risks of water recreation, but do not cover all risks and or dangers.

For additional safeguards, also familiarize yourself with the following general guidelines as well as guidelines provided by nationally recognized Safety Organizations:

- Demand constant supervision. A competent adult should be appointed as a "lifeguard" or water watcher, especially when children are in and around the pool.
- Learn to swim.
- Take the time to learn CPR and first aid.
- Instruct anyone who is supervising pool users about potential pool hazards and about the use of protective devices such as locked doors, barriers, etc.
- Instruct all pool users, including children what to do in case of an emergency.
- Always use common sense and good judgement when enjoying any water activity.
- Supervise, supervise, supervise.

SAVE THESE INSTRUCTIONS

Limited Warranty

Your ZX300 Deluxe Automatic Pool Cleaner has been manufactured using the highest quality materials and workmanship. All Intex products have been inspected and found free of defects prior to leaving the factory. This Limited Warranty applies to the ZX300 Deluxe Automatic Pool Cleaner only.

This limited warranty is in addition to, and not a substitute for, your legal rights and remedies. To the extent that this warranty is inconsistent with any of your legal rights, they take priority. For example, consumer laws across the European Union provide statutory warranty rights in addition to the coverage you receive from this limited warranty: for information on EU-wide consumer laws, please visit the European Consumer Center website at http://ec.europa.eu/consumers/ecc/contact_en/htm.

The provisions of this Limited Warranty apply only to the original purchaser and are not transferable. This Limited Warranty is valid for the period noted below from the date of the initial retail purchase. Keep your original sales receipt with this document, as proof of purchase will be required and must accompany warranty claims or the Limited Warranty will be invalid.

ZX300 Deluxe Automatic Pool Cleaner Warranty – 1 Year
Hose, Roller Brushes & Fittings Warranty – 180 Days

If you find a manufacturing defect in the ZX300 Deluxe Automatic Pool Cleaner during the warranty period, please contact the appropriate Intex Service Center listed in the separate "Authorized Service Centers" sheet. If the item is returned as directed by the Intex Service Center, the Service Center will inspect the item and determine the validity of the claim. If the item is covered by the provisions of the warranty, the item will be repaired or replaced, with the same or comparable item (at Intex's choice) at no charge to you.

Other than this warranty, and other legal rights in your country, no further warranties are implied. To the extent possibly in your country, in no event shall Intex be liable to you or any third party for direct or consequential damages arising out of the use of your ZX300 Deluxe Automatic Pool Cleaner, or Intex or its agents' and employees' actions (including the manufacture of the product). If your country does not allow the exclusion or limitation of incidental or consequential damages, this limitation or exclusion does not apply to you.

You should note that this limited warranty does not apply in the following circumstances:

- If the ZX300 Deluxe Automatic Pool Cleaner is subject to negligence, abnormal use or application, accident, improper operation, improper voltage or current contrary to operating instructions, improper maintenance or storage;
- If the ZX300 Deluxe Automatic Pool Cleaner is subject to damage by circumstances beyond Intex's control, including but not limited to, ordinary wear and tear and damage caused by exposure to fire, flood, freezing, rain, or other external environmental forces;
- To parts and components not sold by Intex; and/or.
- To unauthorized alterations, repairs or disassembly to the ZX300 Deluxe Automatic Pool Cleaner by anyone other than Intex Service Center personnel.

Injury or damage to any property or person is not covered by this warranty.

Read the owner's manual carefully and follow all instructions regarding proper operation and maintenance of your ZX300 Deluxe Automatic Pool Cleaner. Always inspect your product prior to use. This limited warranty will be void if use instructions are not followed.

SAVE THESE INSTRUCTIONS